

Wireless Charging Module

Power: 10W 241320-63-1

Power: 15W 241320-63-2



WIRELESS CHARGING

VW Tiguan II 2016>

VW Tiguan II (Facelift) 2020>

VW Tiguan Allspace 2017>

D

EINBAUANLEITUNG

Schwierigkeitsgrad



GB

INSTALLATION GUIDE

level of difficulty



A

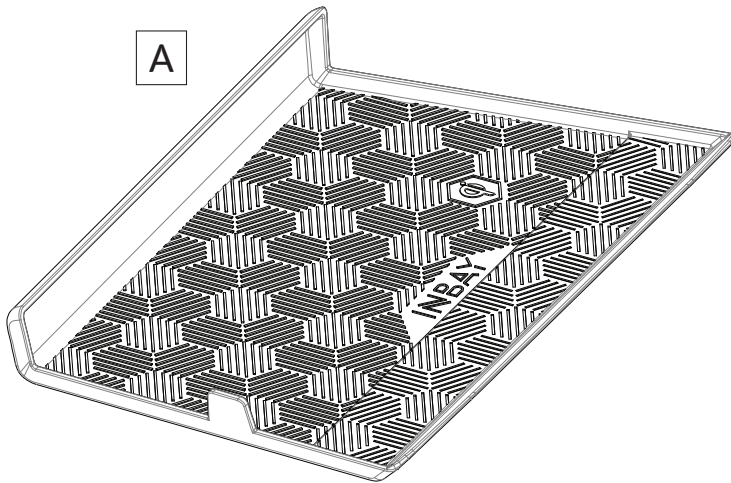

Nur für Fahrzeuge mit herausnehmbarem Blindeckel unter der OEM Gummimatte. Modelle mit fest verbauter Ablage benötigen eine neue Original-VW Mittelkonsole (VW Teile-Nr.: 5NB 863 241 F \*\*\*)

Only for models with dispatchable blind cover beneath the OEM rubber mat. Models with closed tray require a new OEM-VW center console (VW part-no.: 5NB 863 241 F \*\*\*)

B

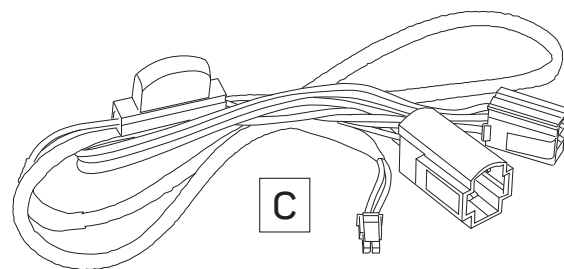
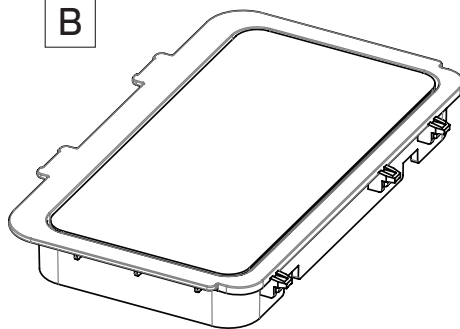

C

- A Antirutschmatte
- B Wireless Charging Subsystem
- C Y-Kabel (Anschluss an +12V Buchse)

- A anti-skid mat
- B wireless charging subsystem
- C Y-cable (connects to +12V socket)

Sachgemäße Installation unter Beachtung dieser Einbauanleitung erforderlich. Achten Sie auf korrekte Anschlüsse. Verlegen Sie die Kabel so, dass Sie weder geknickt, gequetscht oder beschädigt werden können. Sorgen Sie dafür, dass sich die Kabel nicht in Gegenständen verfangen können.

An appropriate installation in observance of these operating instructions is necessary. Please make sure the wiring is arranged so it is not bended or crimped due to the risk of cable break. Make sure that all connections are correct. Route the cable away from moving parts, do not allow the cable to be entangled, pinched or damaged in any way.

Wir können keine Haftung für Schäden übernehmen, welche durch unsachgemäße Installation oder Nutzung verursacht wurden. Verwenden Sie darum ausschließlich das mitgelieferte Montagematerial.

We will not be liable for damage due to improper installation or utilization. Use the specified accessory parts to prevent product failure.

Technische Änderungen vorbehalten, alle Angaben ohne Gewähr.

Subject to technical modifications; no responsibility is accepted for the accuracy of this information.

Das „Qi“ Logo ist Warenzeichen des „Wireless Power Consortium“

The “Qi” symbol is a trademark of the “Wireless Power Consortium”

VW Tiguan

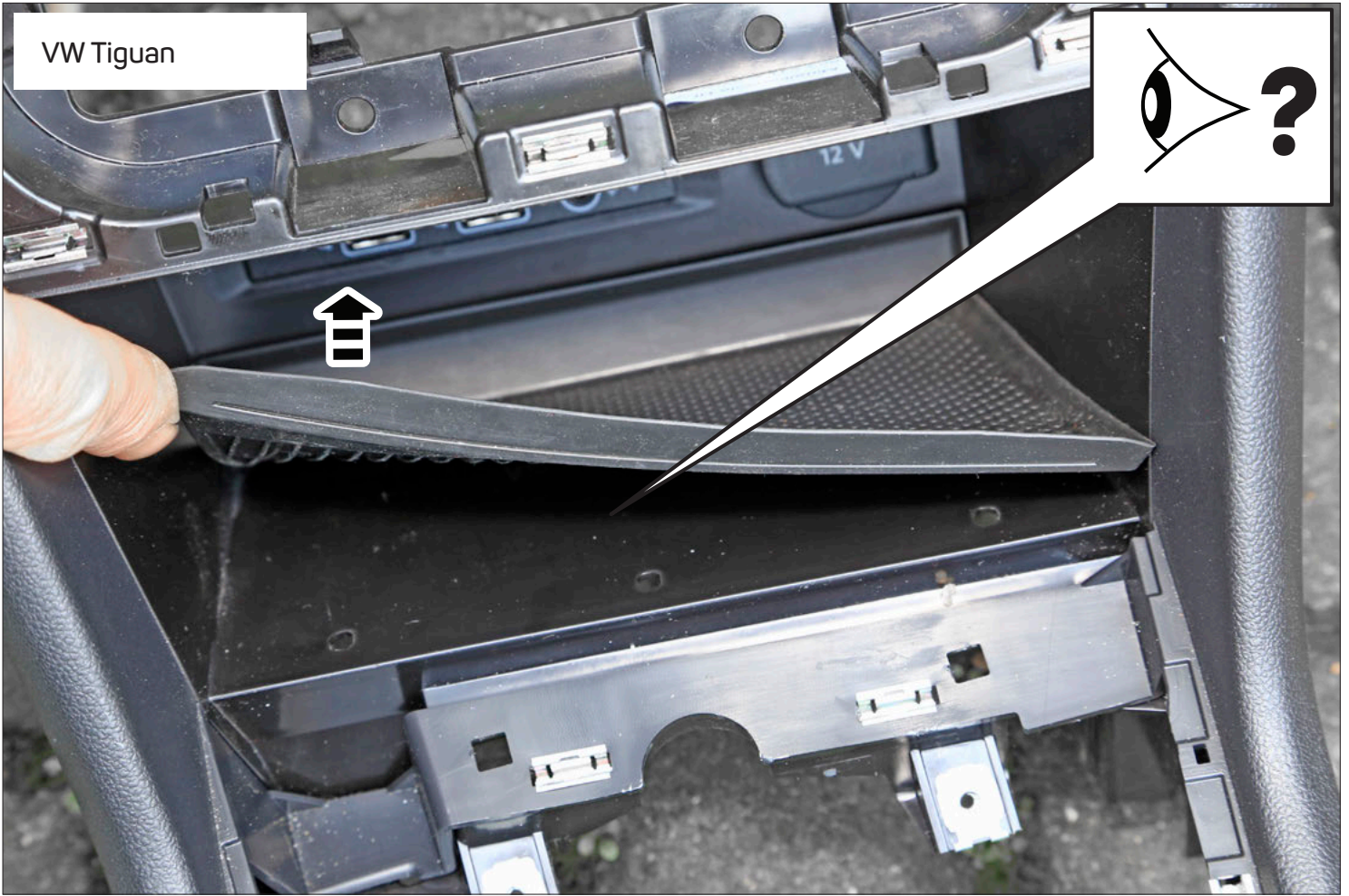

Modelle mit Blinddeckel:  
weiter auf Seite 21

Models with blind cover:  
proceed on page 21





Beispiel / sample: 5NB 863 241 F 82V

Eine neue Original-Mittelkonsole (VW-Teile Nr.: 5NB 863 241 F \*\*\*) mit Aussparung für das Subsystem wird benötigt. Bitte überprüfen Sie vor Bestellung die Farbe Ihrer Innenausstattung anhand der Fahrgestellnummer.

A new original panel (VW part no.: 5NB 863 241 F \*\*\*) with opening for the subsystem is required. Please check the colour on basis of the VIN (vehicle identification number) before ordering.



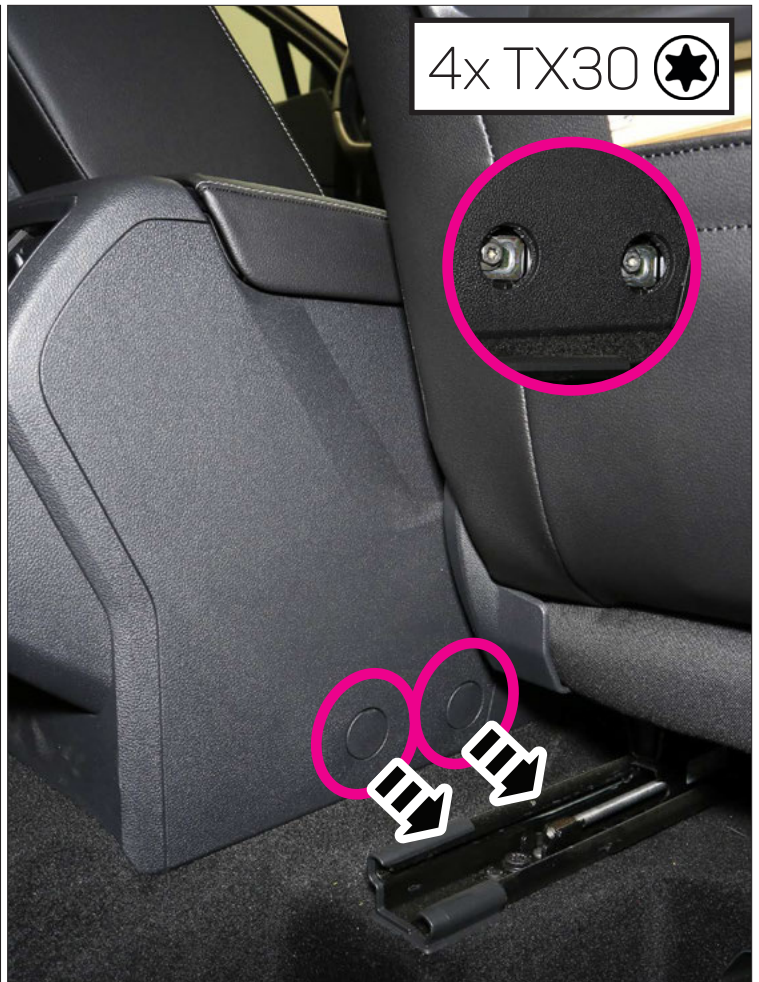
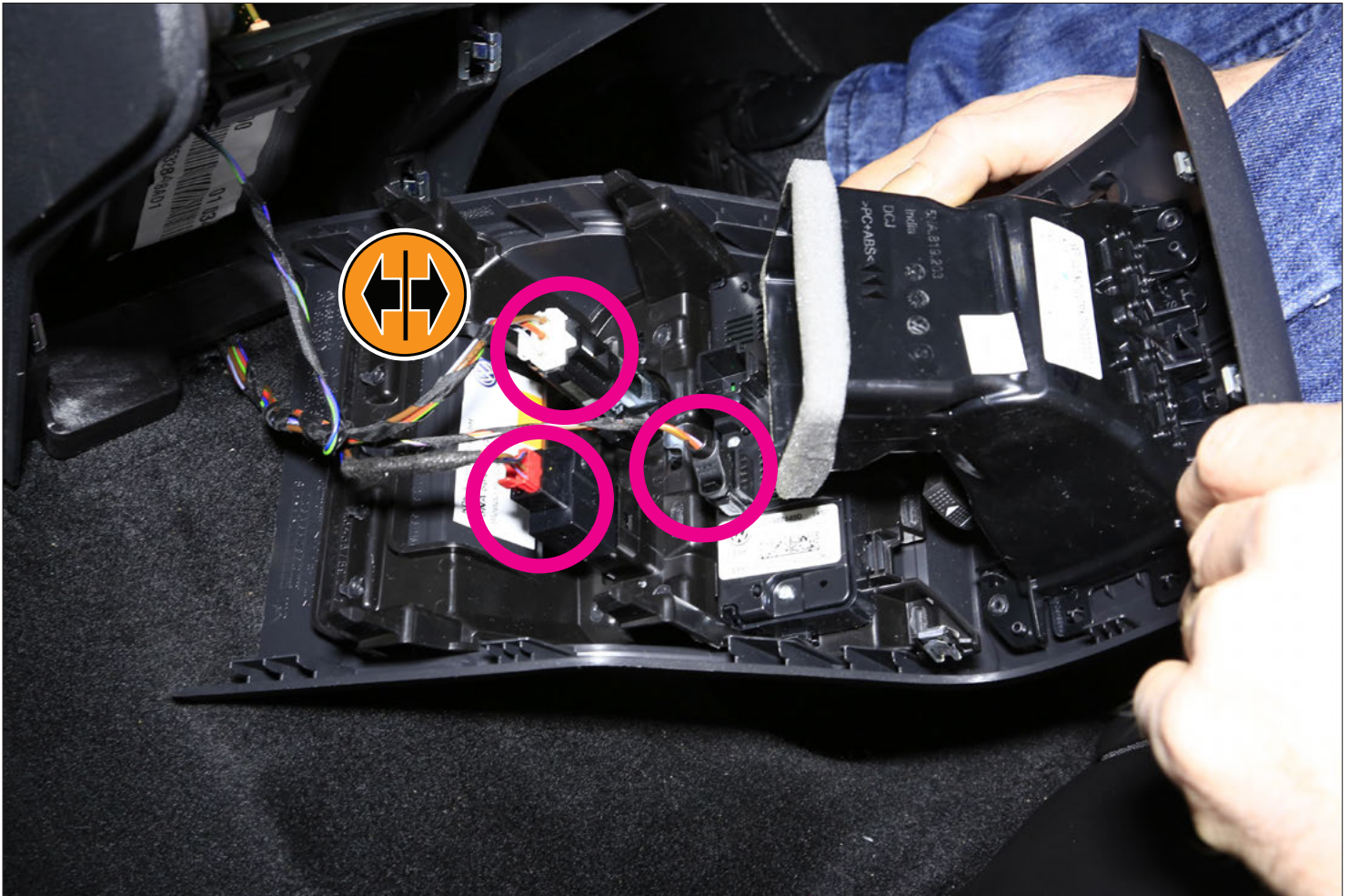





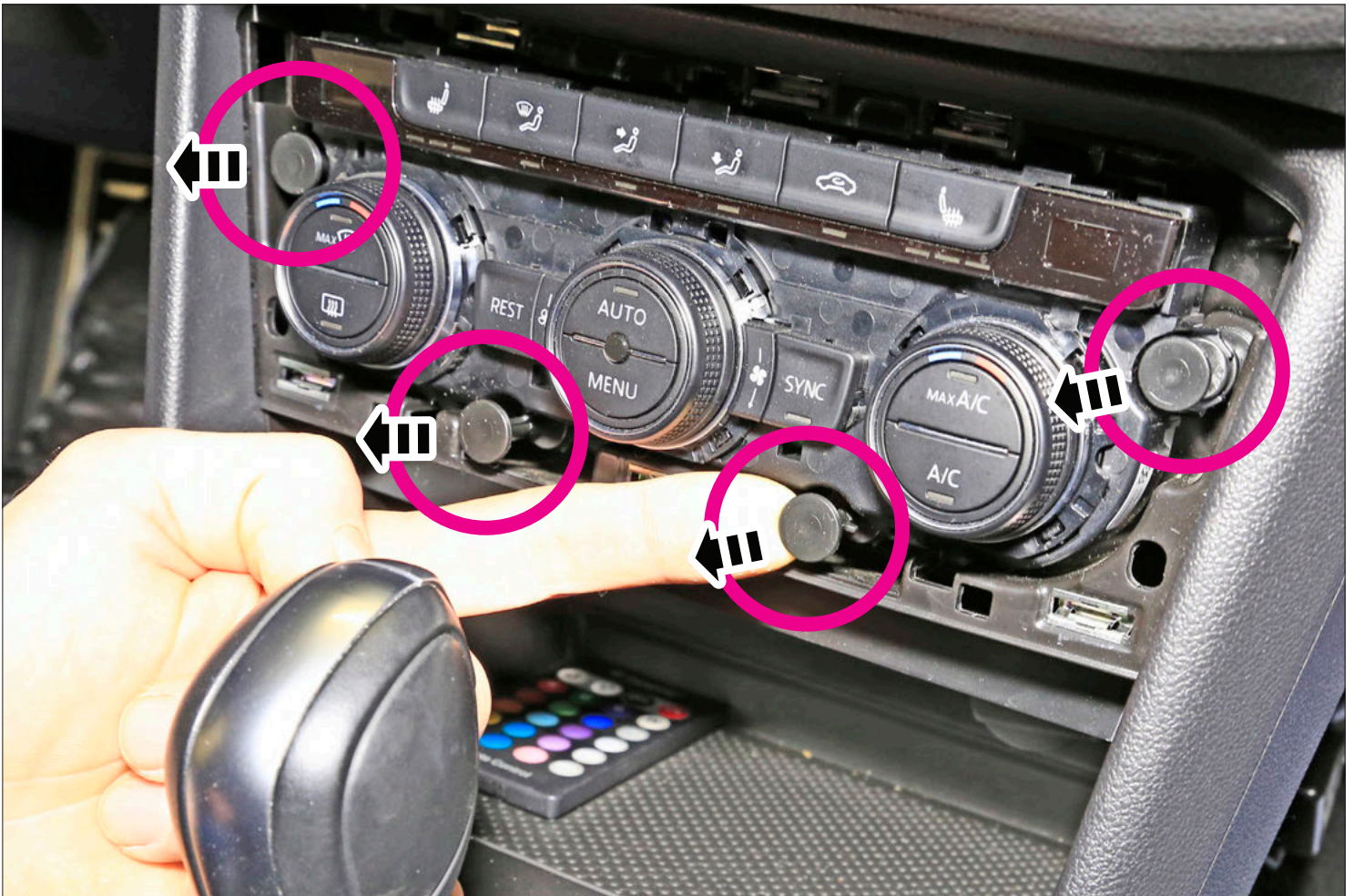

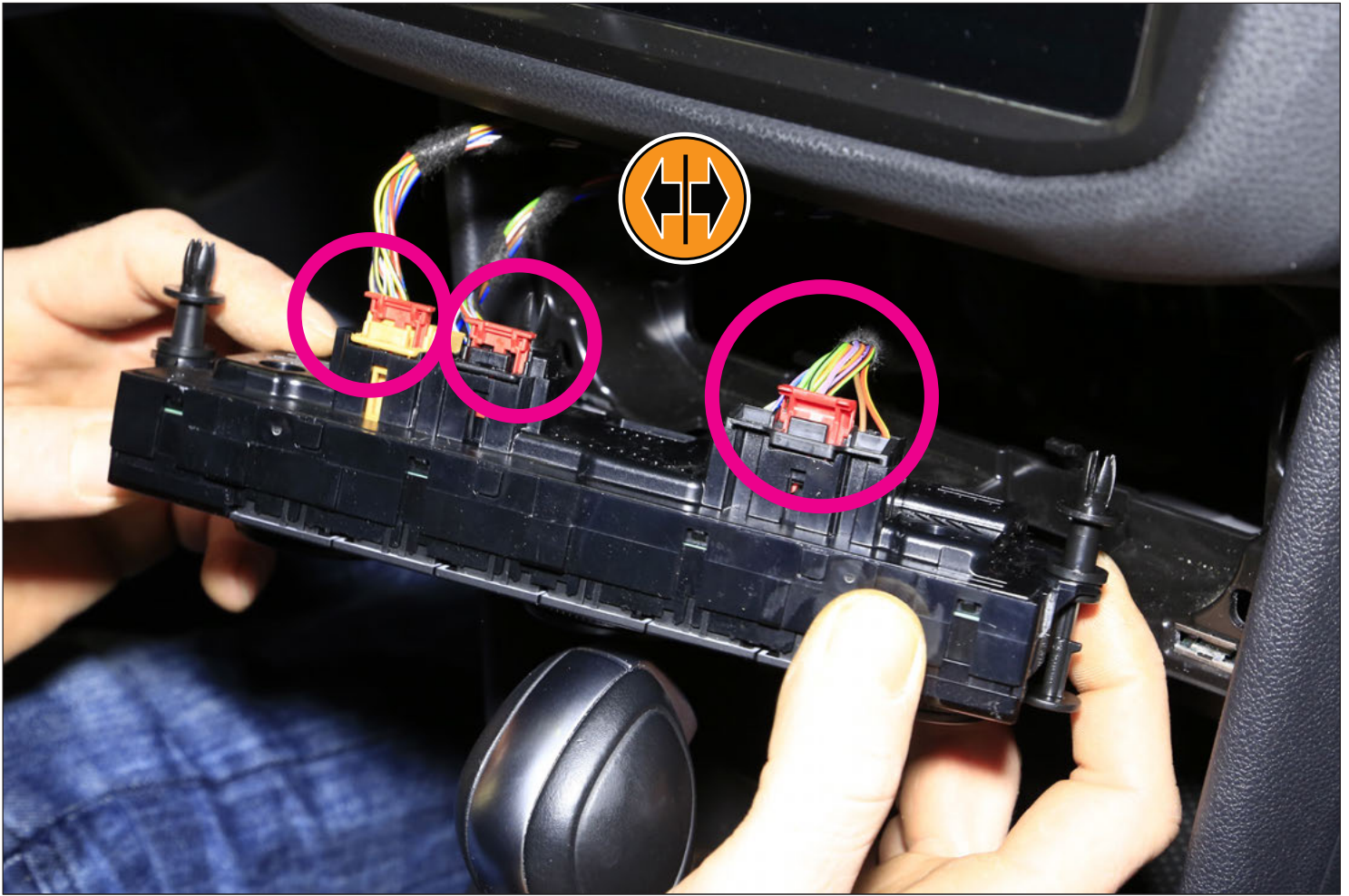



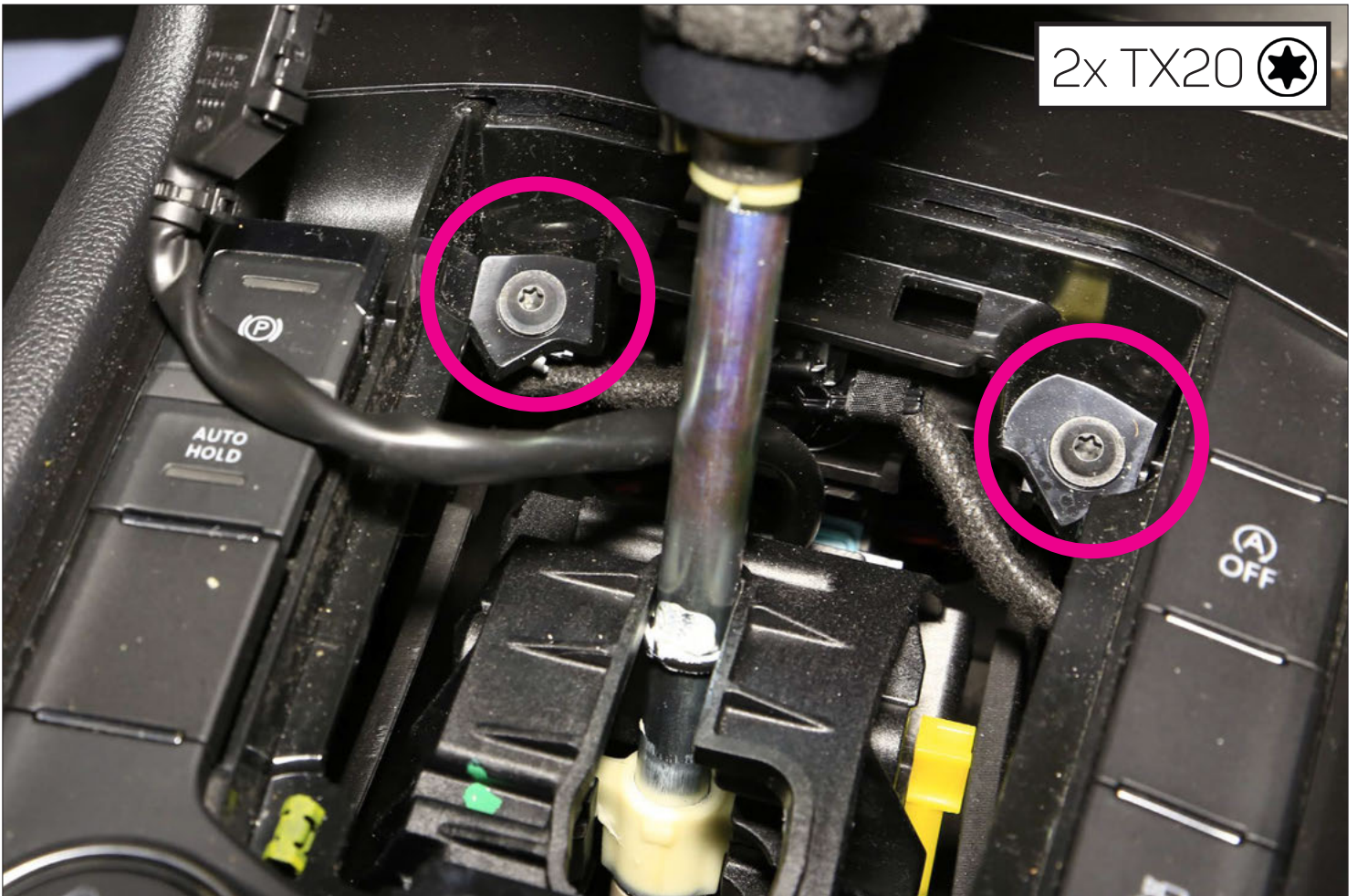
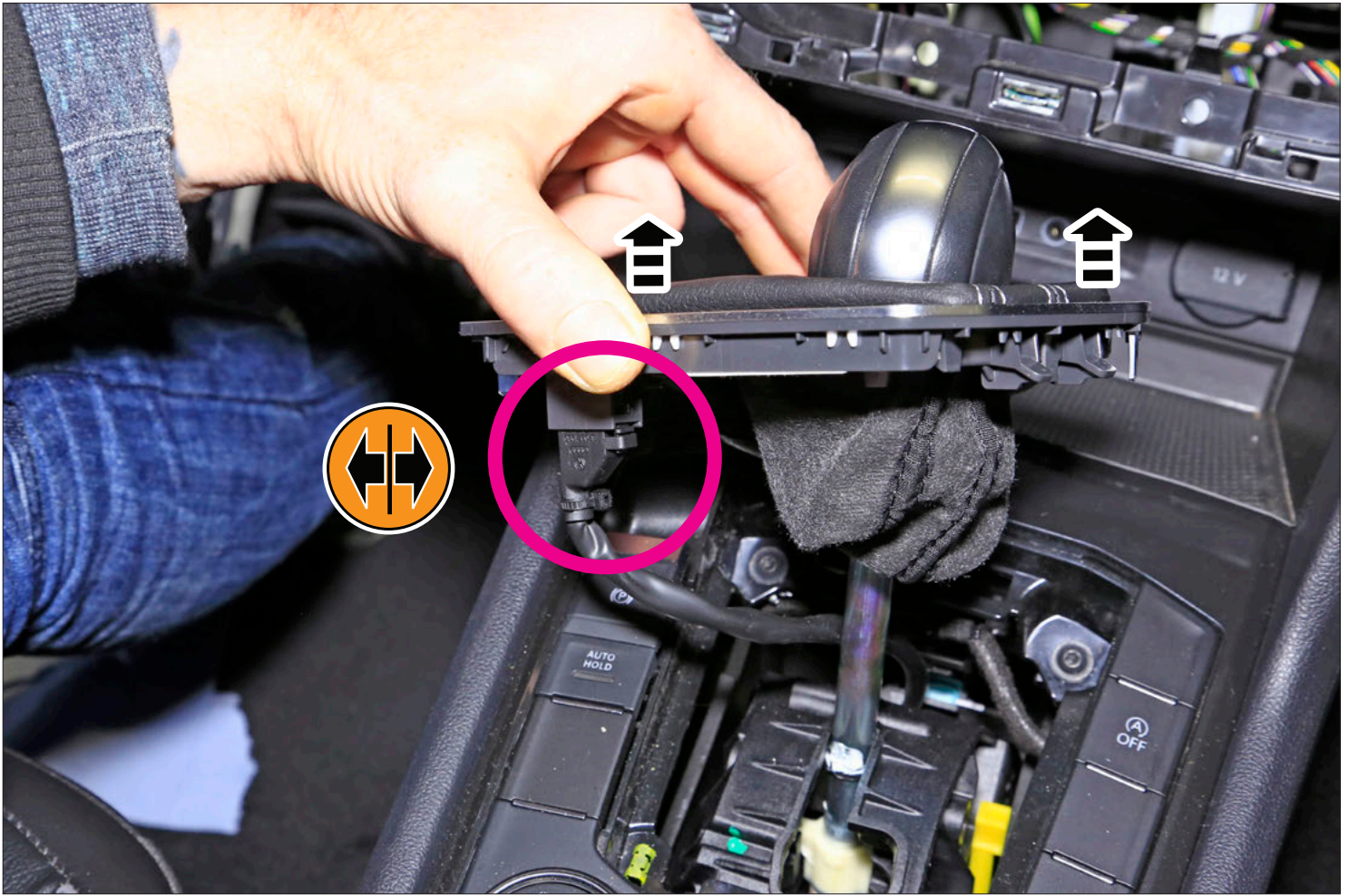

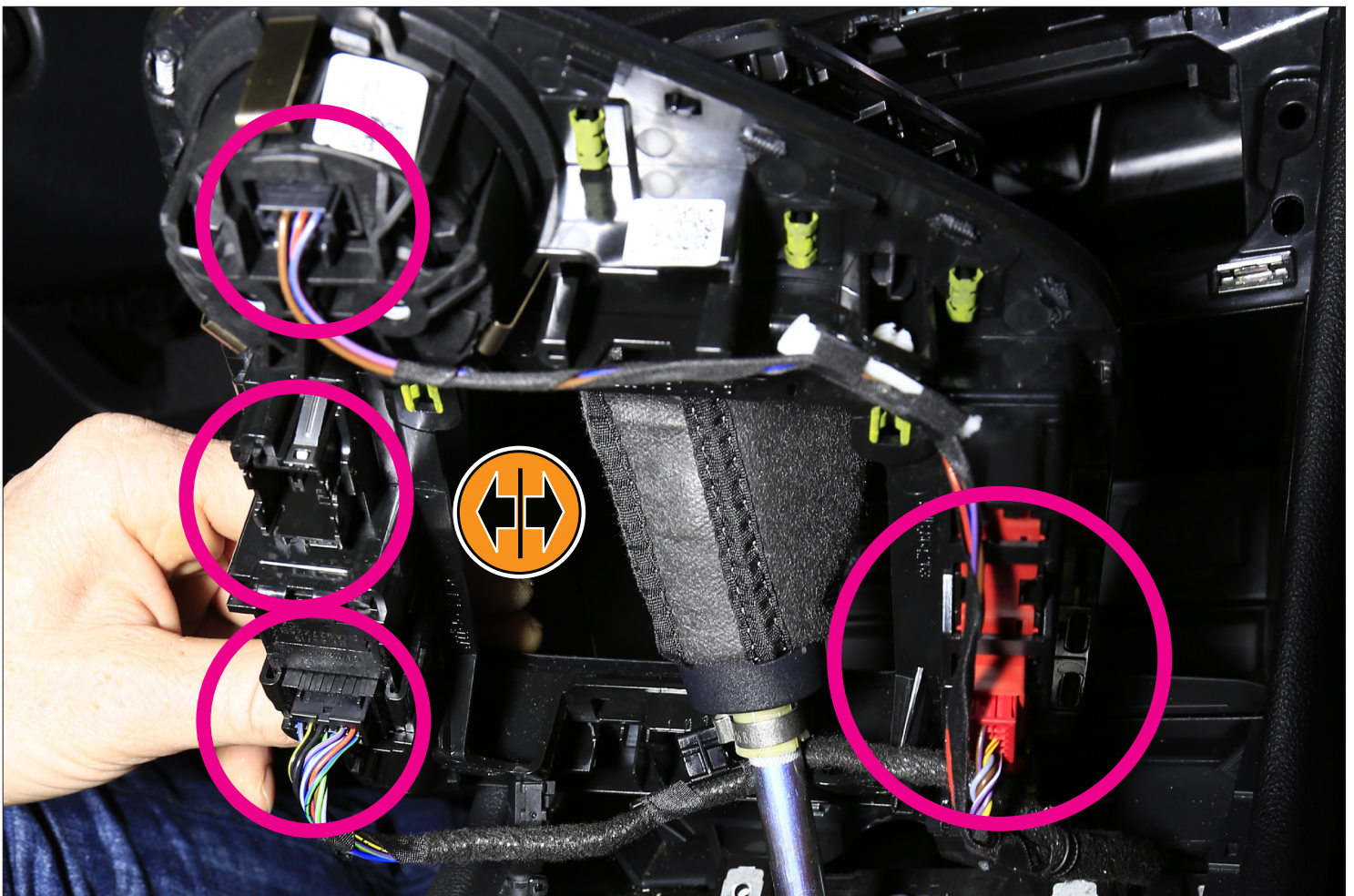

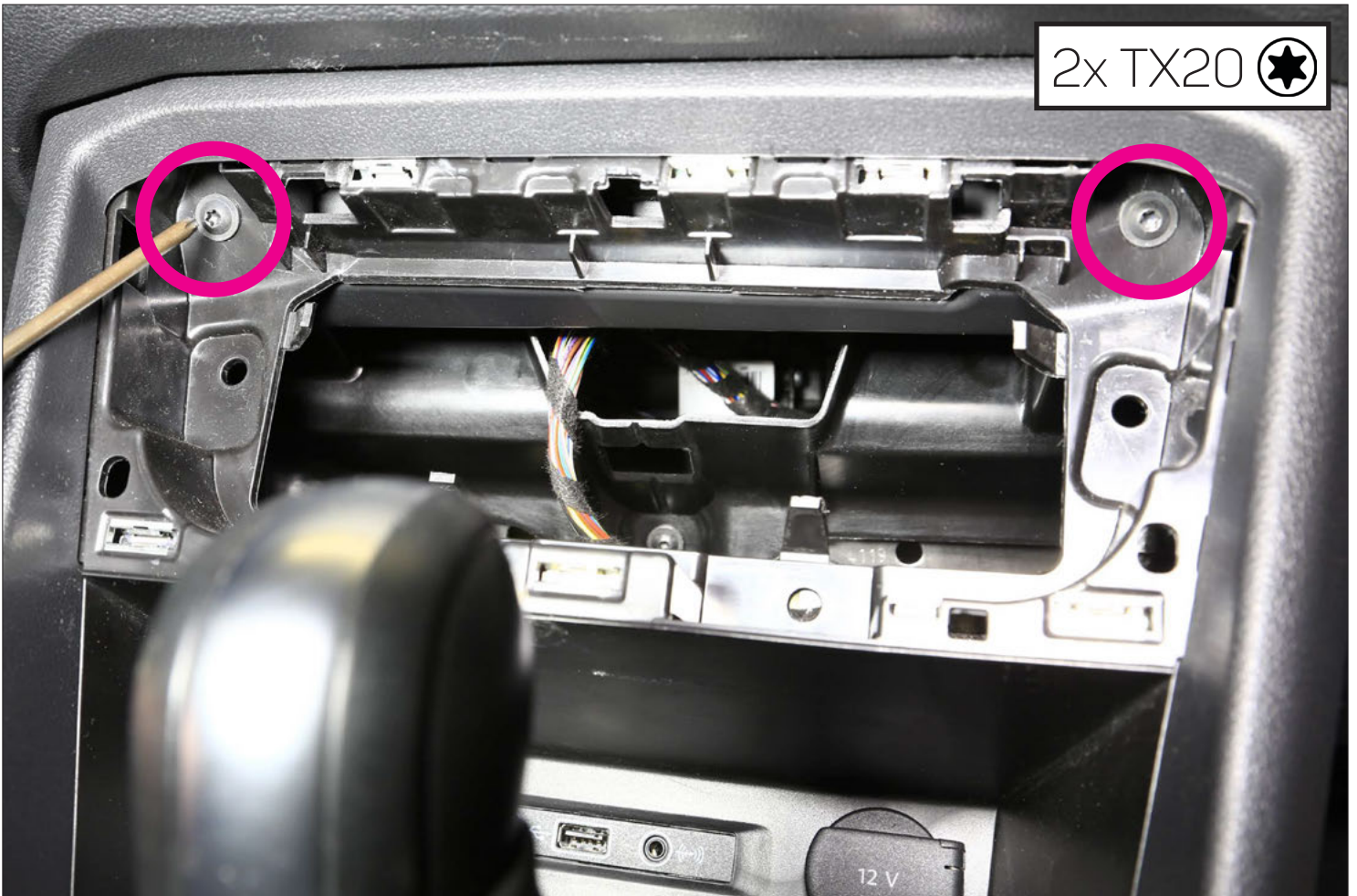

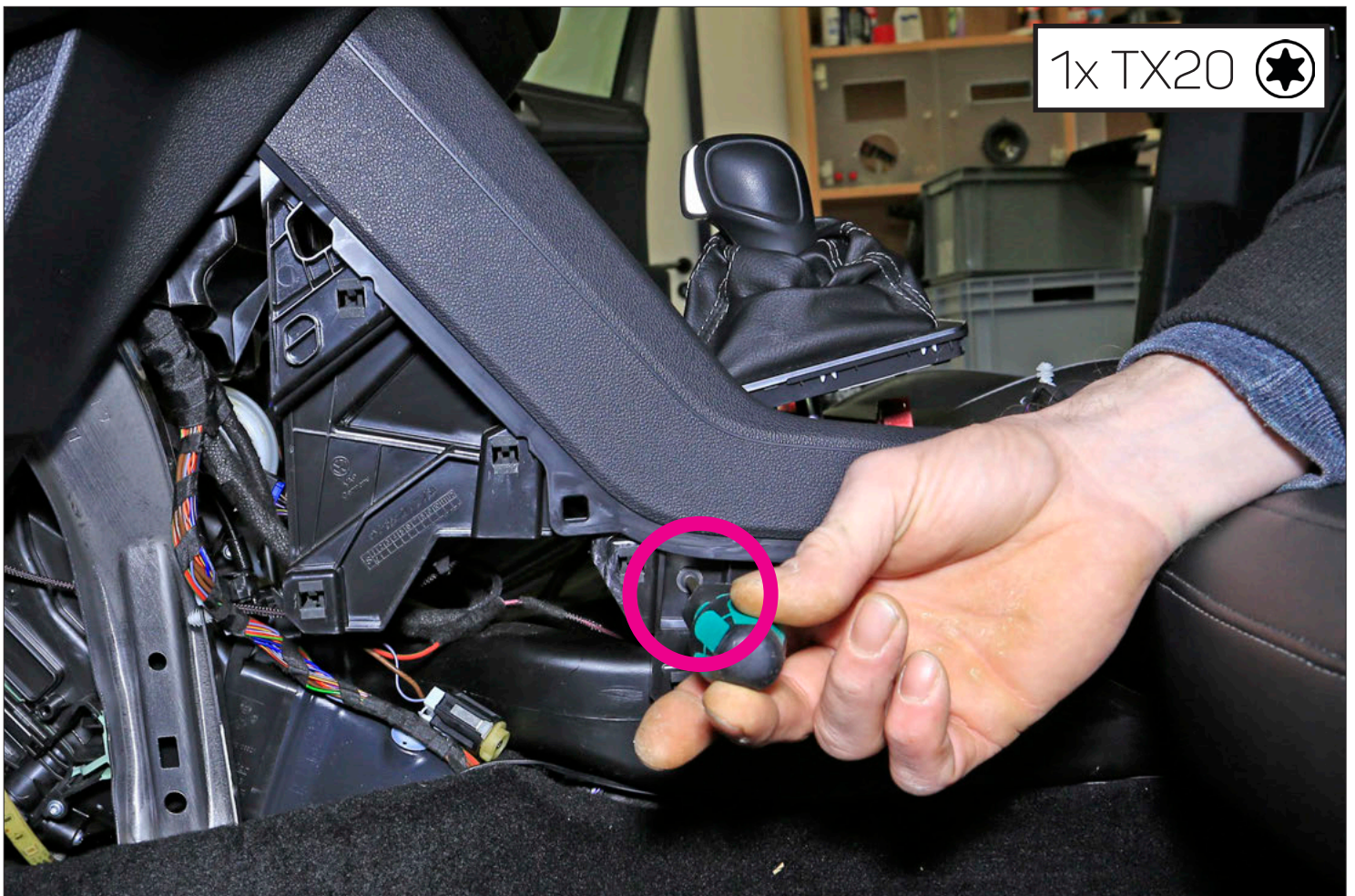

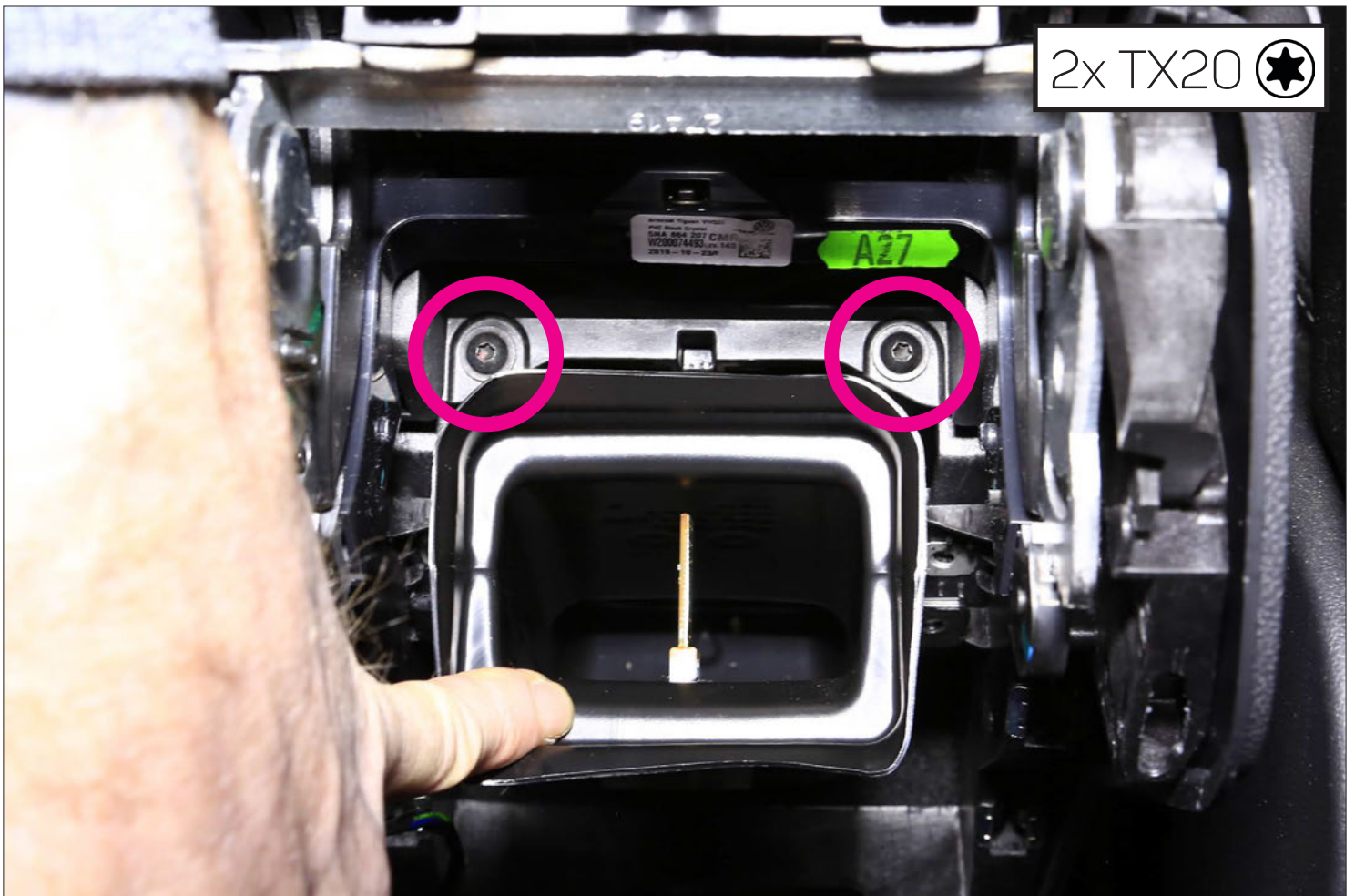
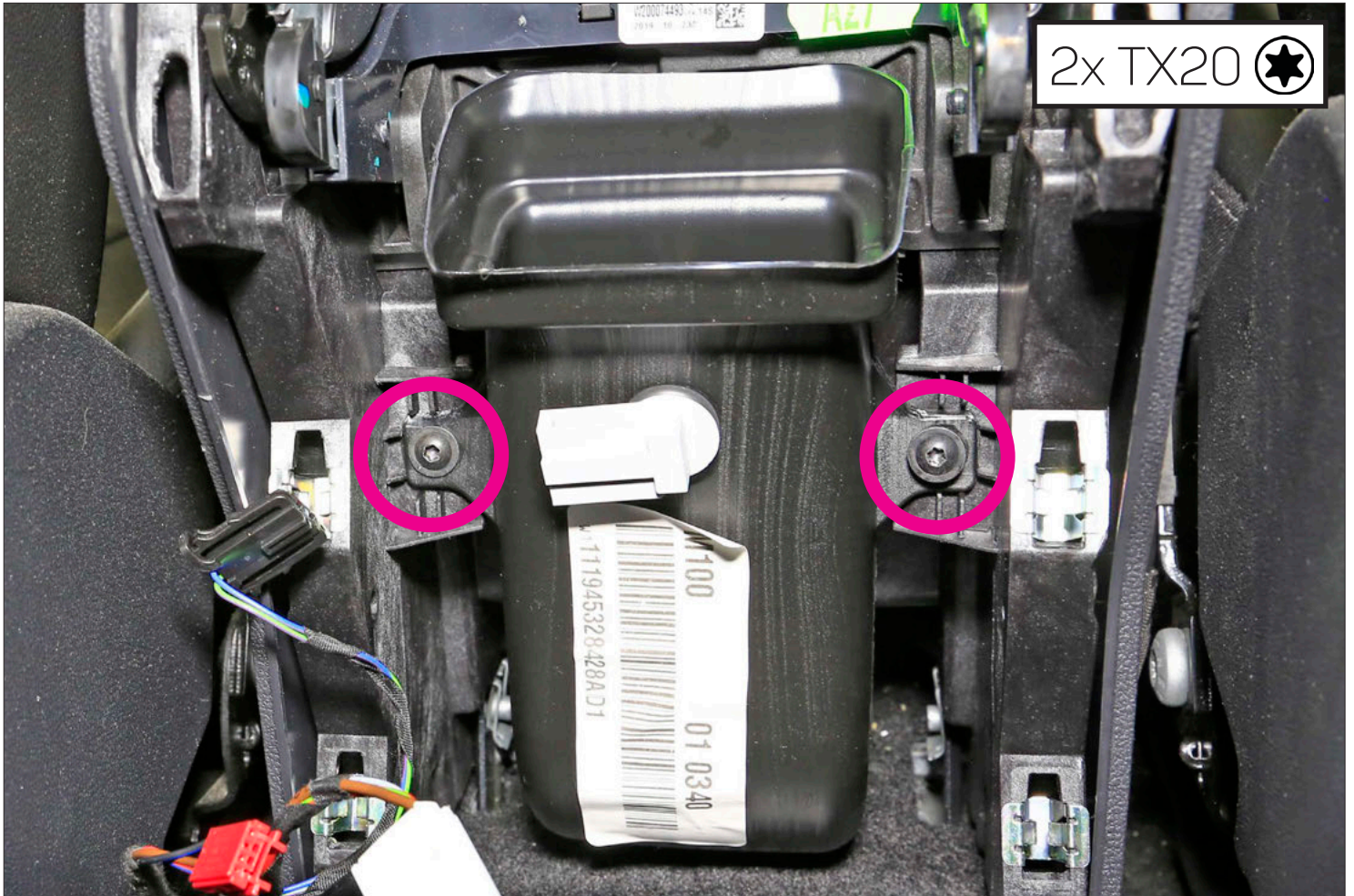



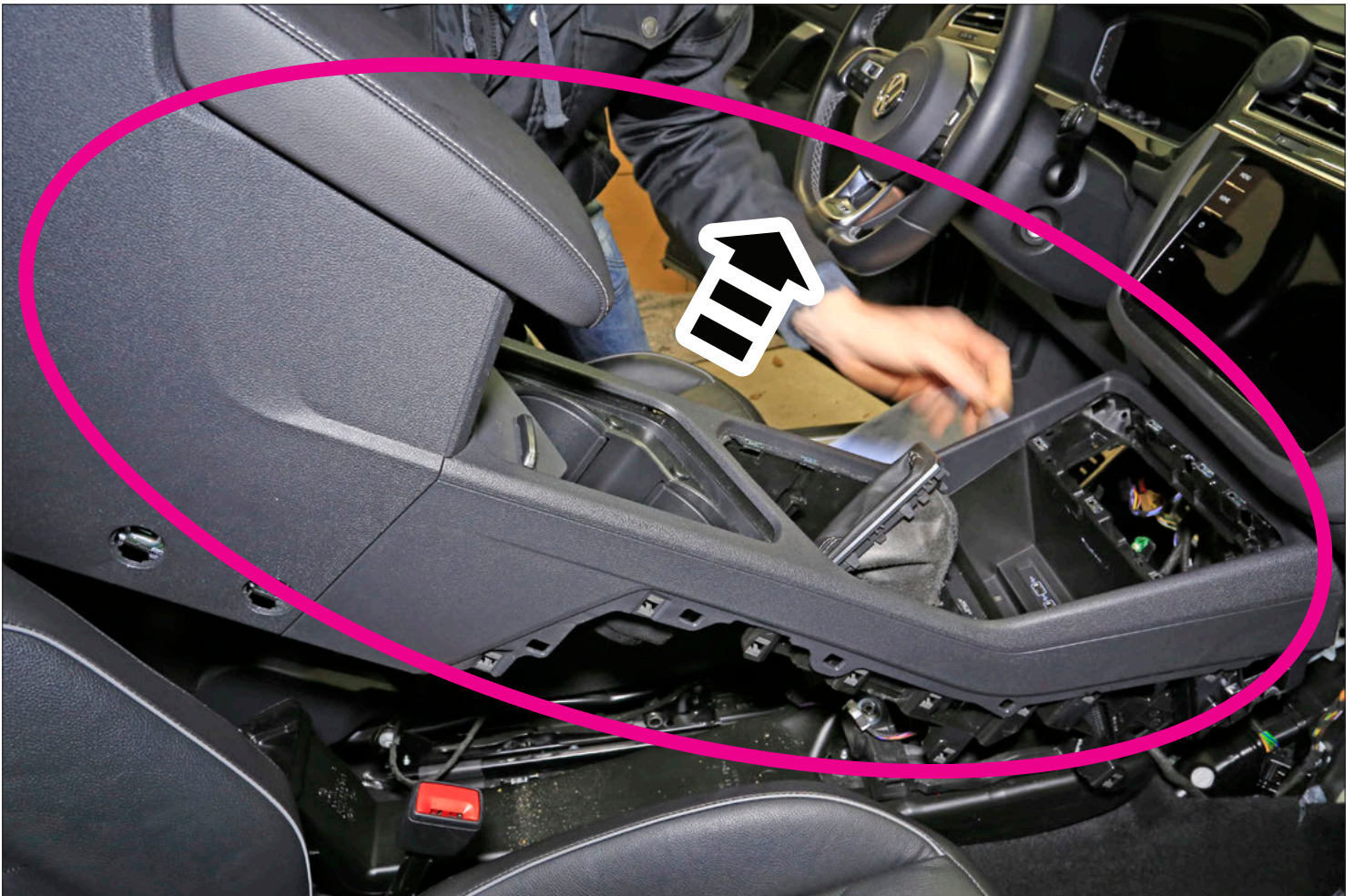
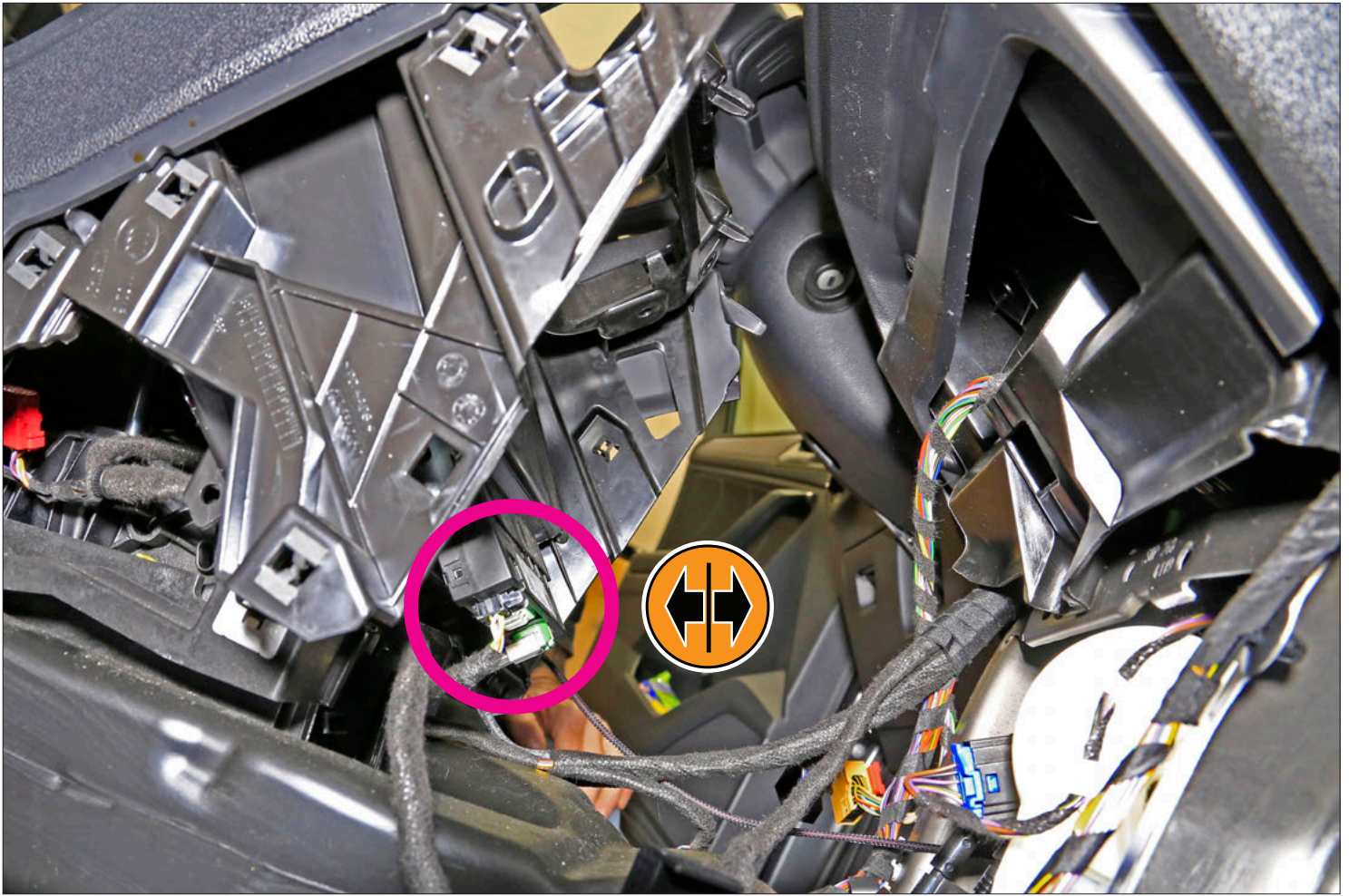

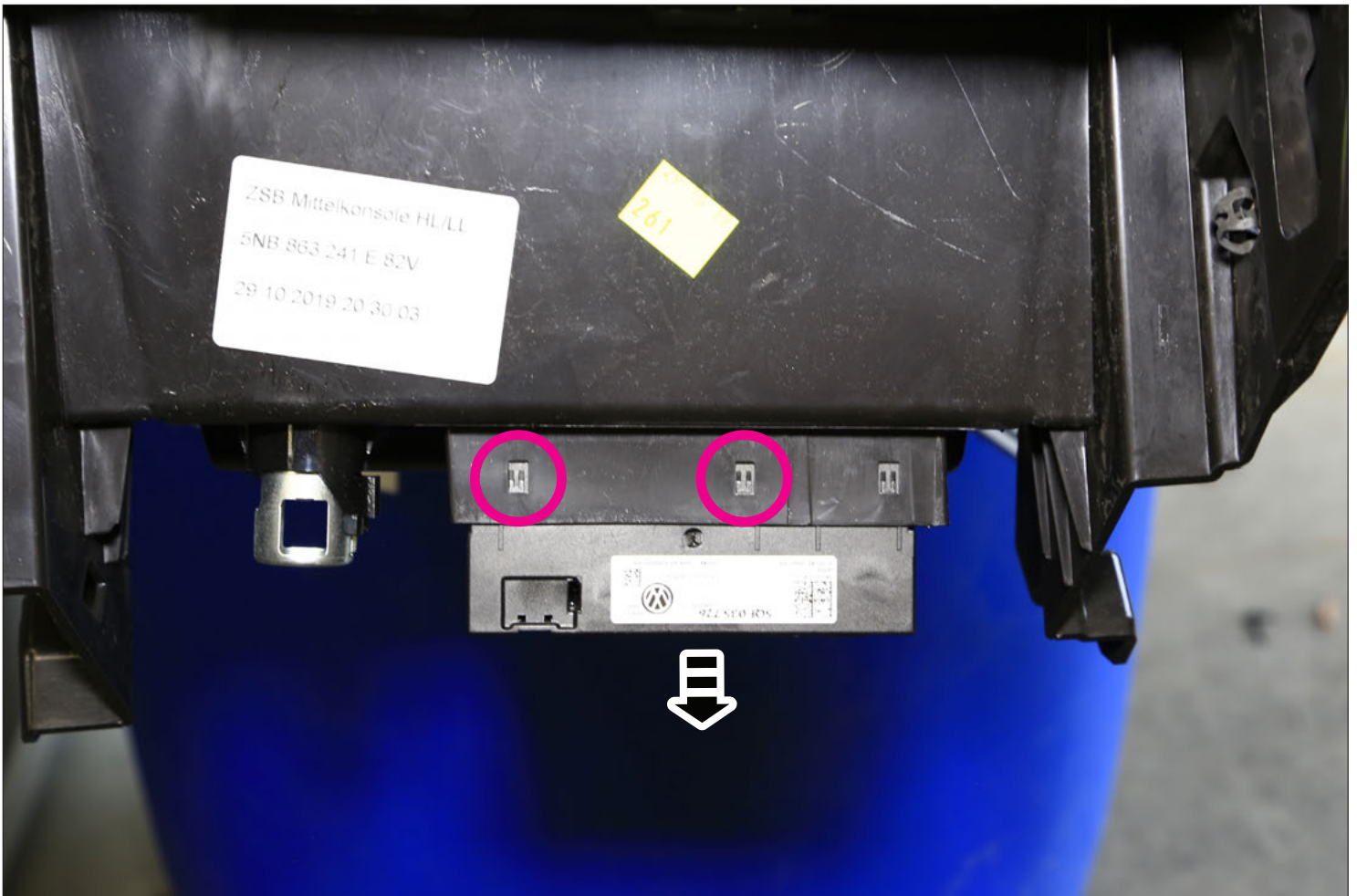



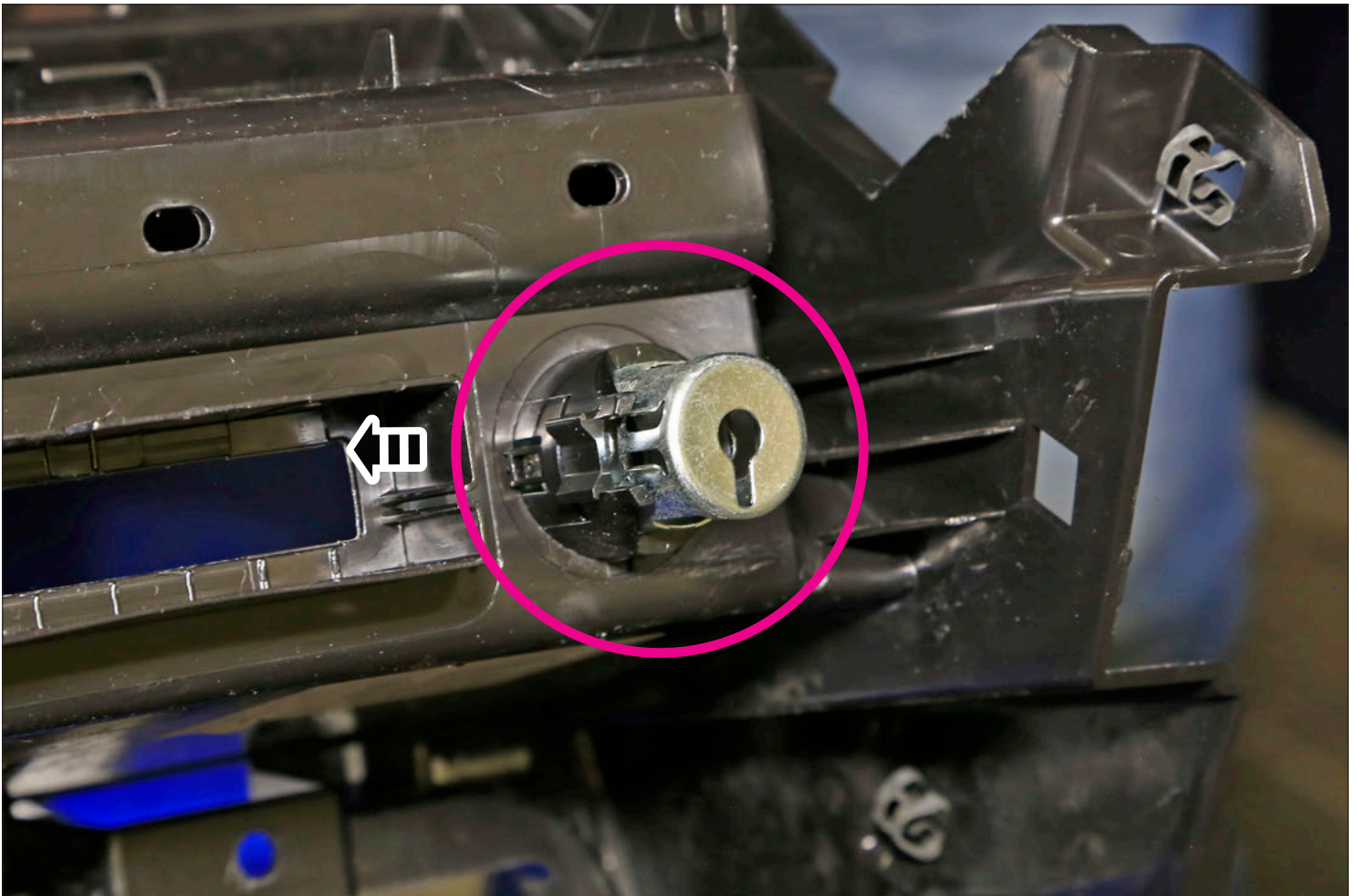





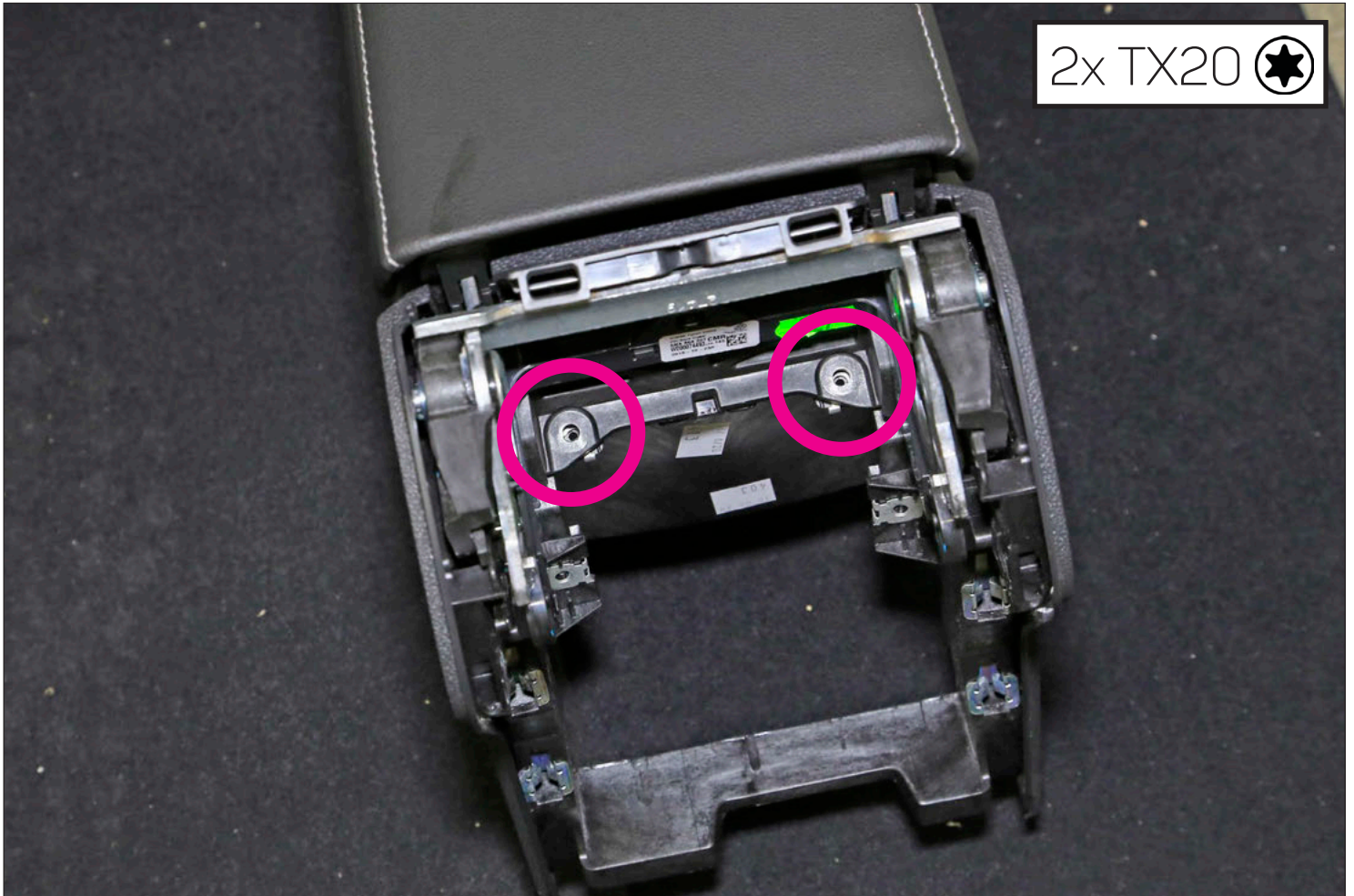

2x TX20 



Modelle mit Blinddeckel  
Models with blind cover

1x TX20 



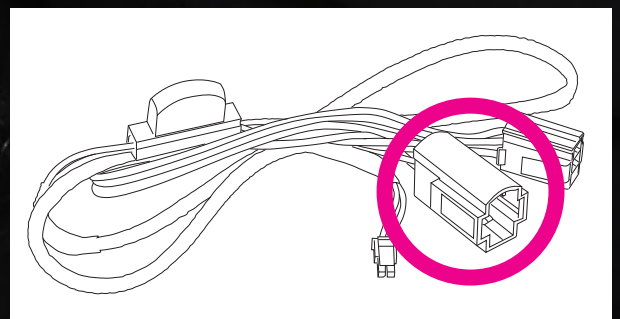
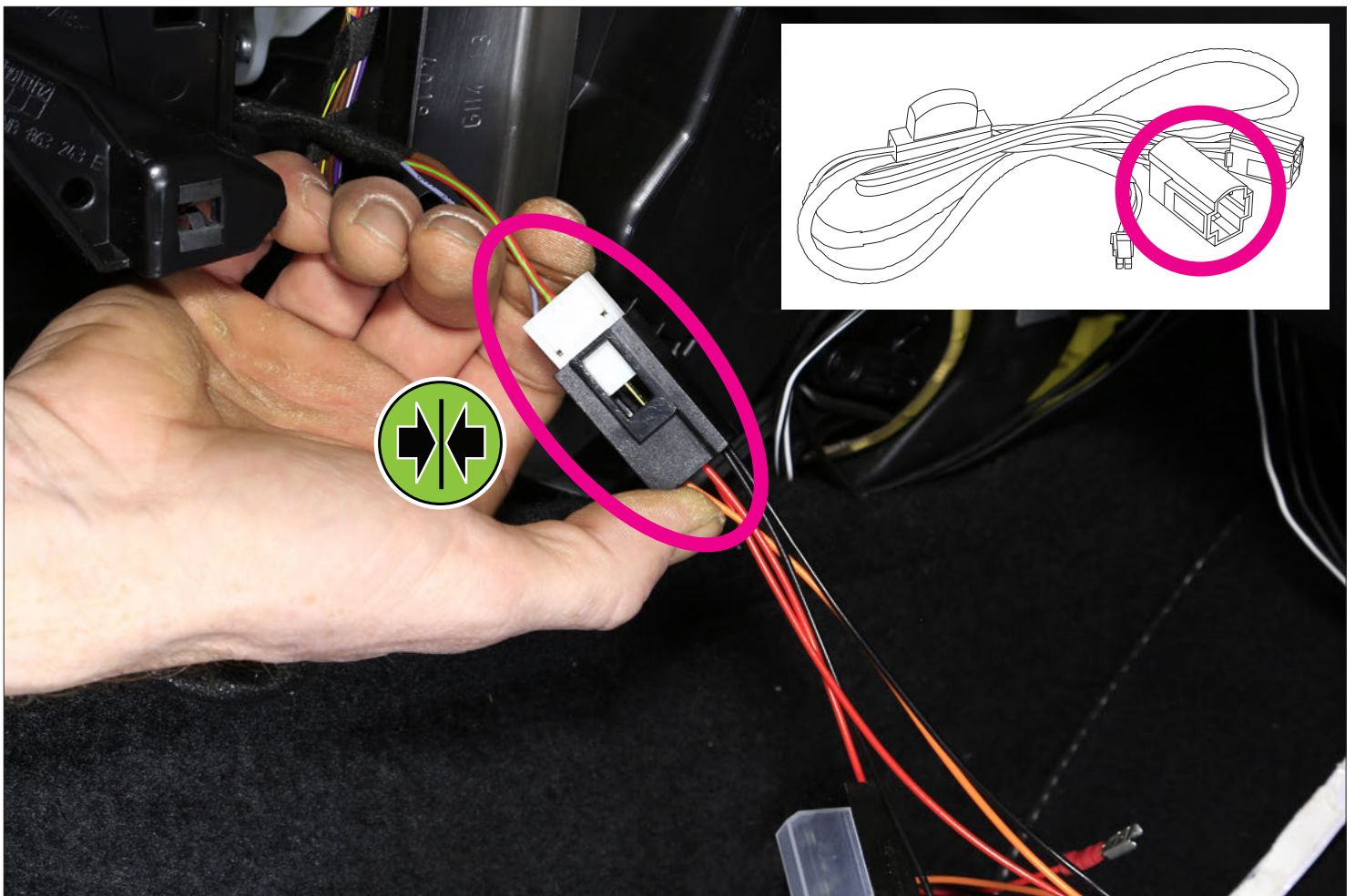
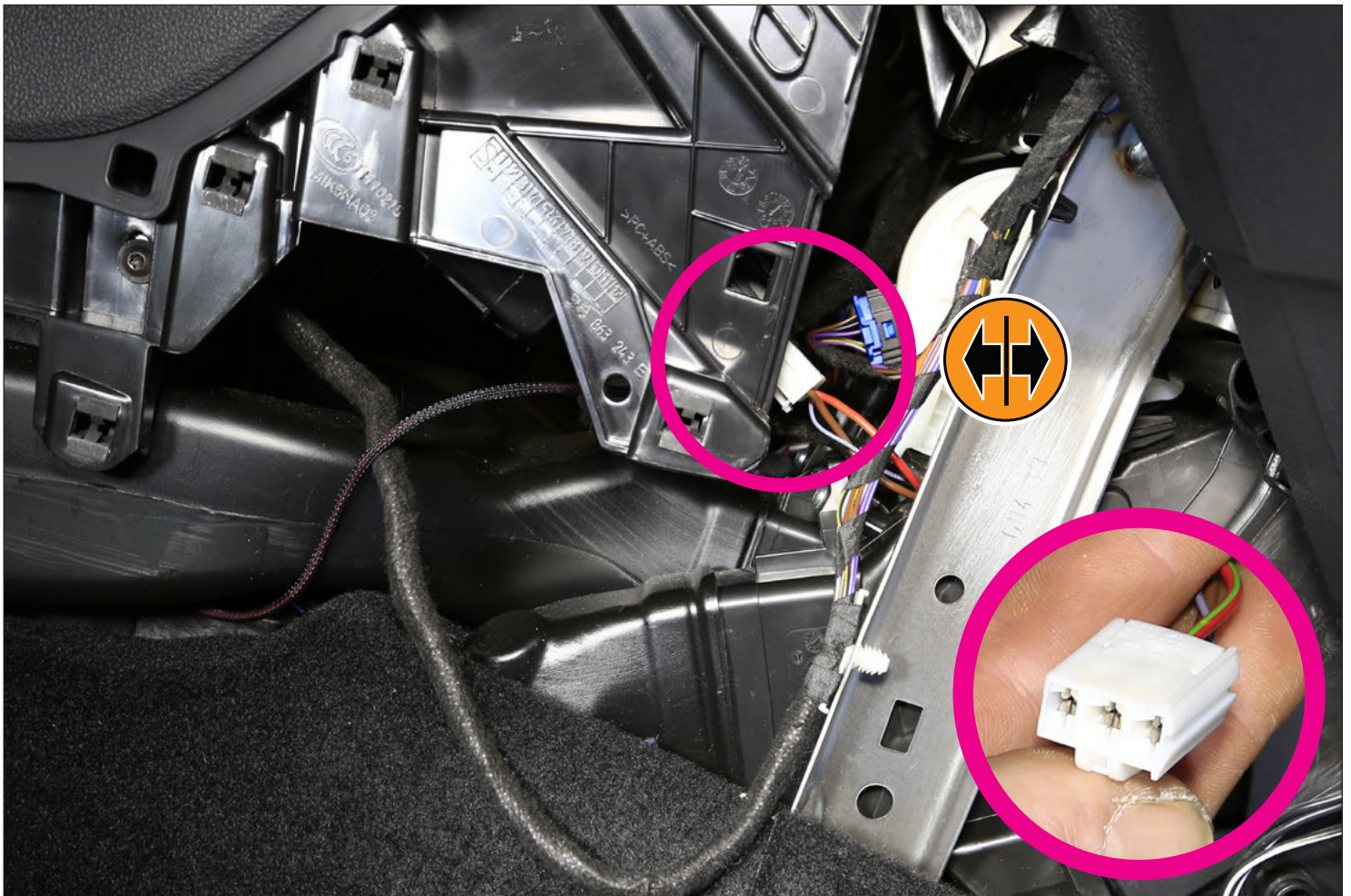

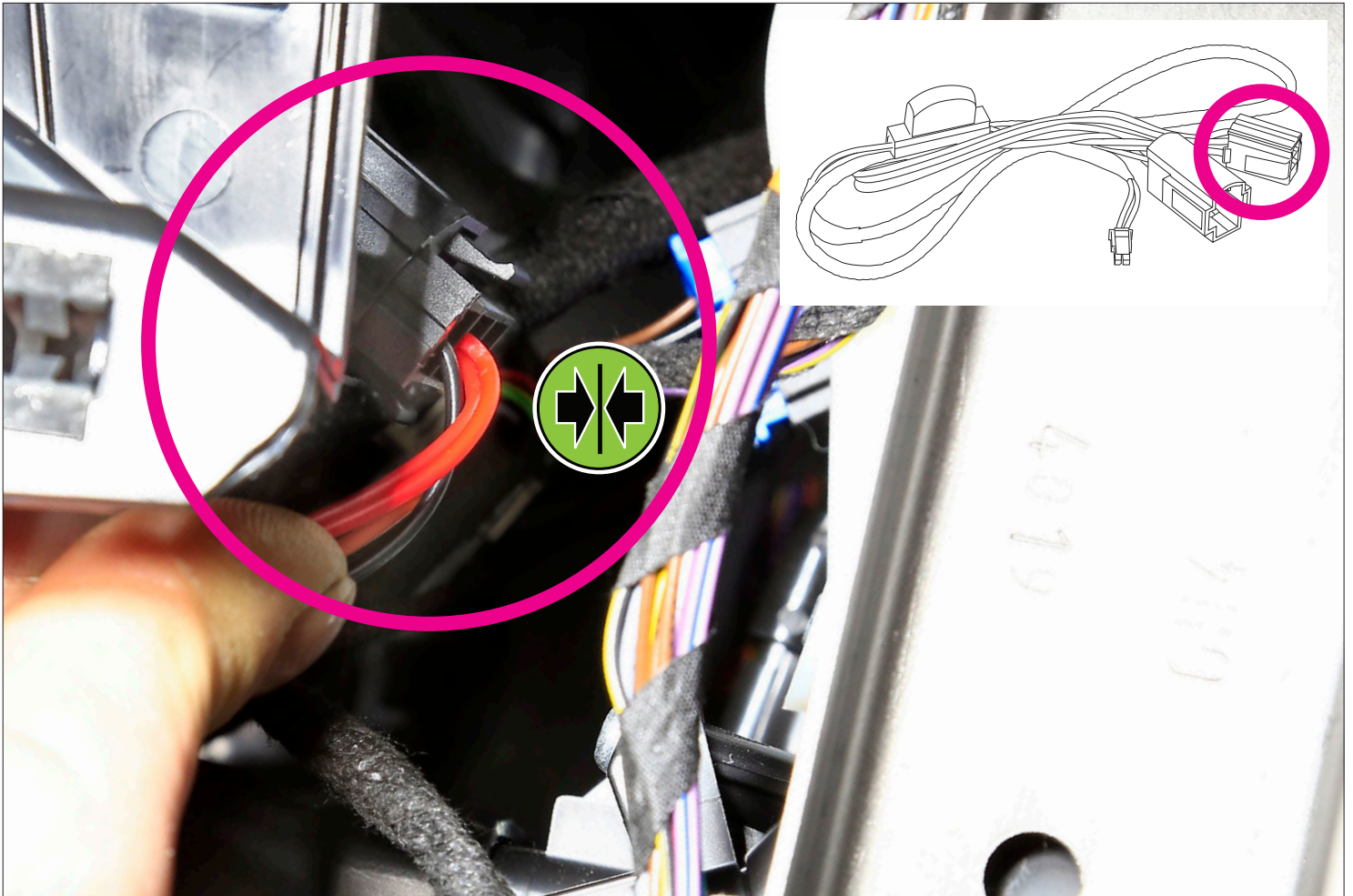

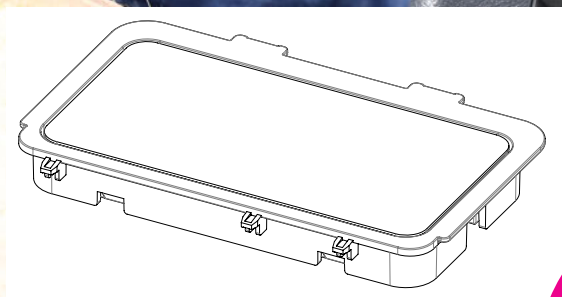
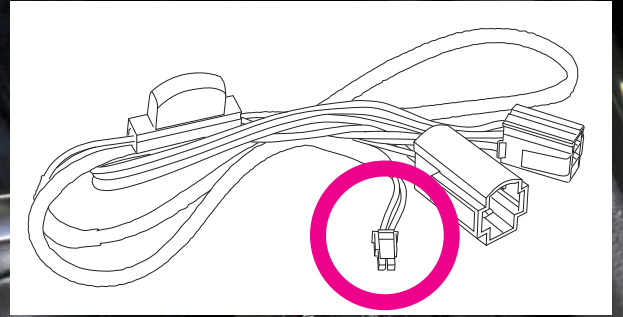
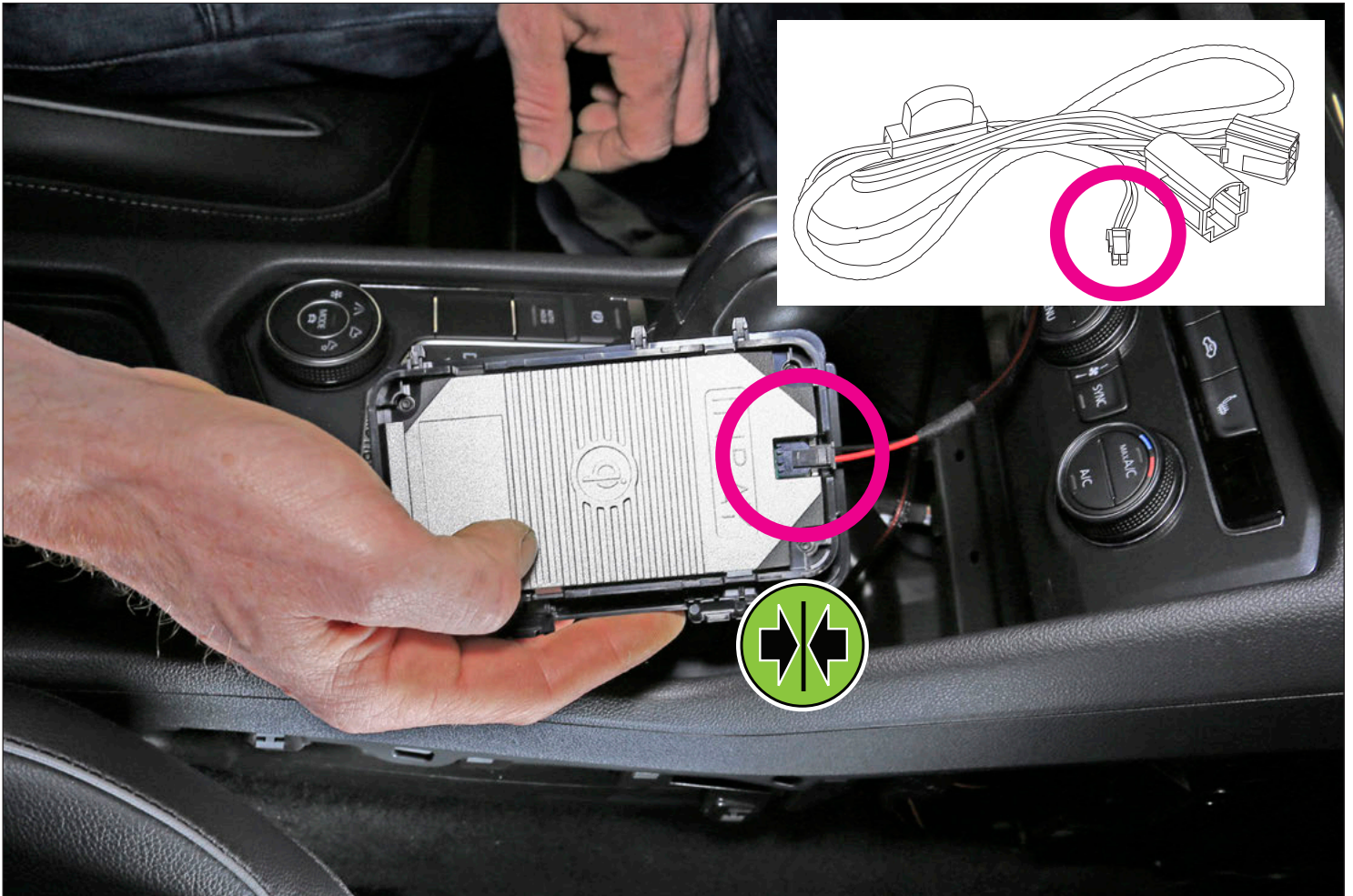



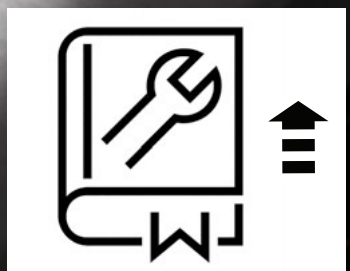





## INTEGRATED FOREIGN OBJECT DETECTION (FOD)



### WICHTIGE INFORMATION:

Bitte legen Sie keine anderen Gegenstände wie z.B. Münzen, Kreditkarten etc. in die INBAY Ablage. **Insbesondere Smartphones mit angebrachtem Ring Ständer dürfen nicht verwendet werden** - da ansonsten aus Sicherheitsgründen der Ladevorgang durch die integrierte Fremdeilerkennung (FOD) gestoppt wird.

### IMPORTANT INFORMATION:

Please don't place any other objects such as coins, credit cards etc. onto the INBAY surface. **Especially smartphones with attached ring stand holder must not be used!** - otherwise the integrated Foreign Object Detection (FOD) will interrupt wireless charging for safety reasons.

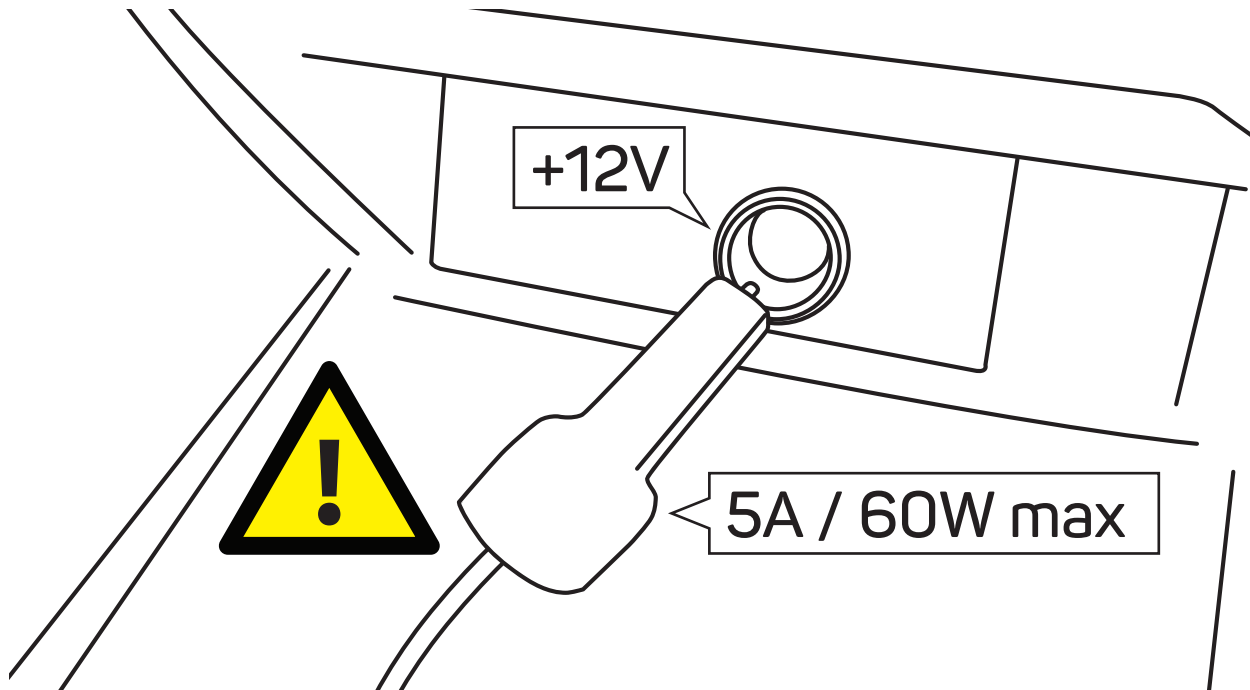

**ACHTUNG!** Nach der Installation dürfen keine Geräte/Verbraucher mit mehr als **5A / 60W** an der +12V Buchse betrieben werden, da sonst die Gefahr einer Überspannung besteht!

**ATTENTION!** After installation, devices/consumers with more than **5A / 60W** shall not be operated on the +12V socket. Otherwise a risk of overvoltage can occur!

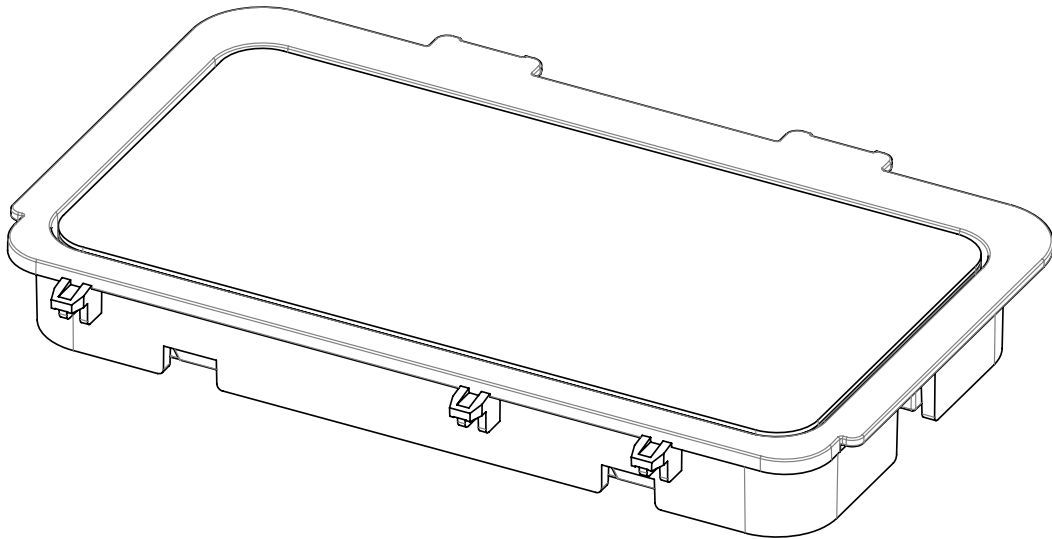

241320-63-1

Input Voltage	12V (DC)	
Output Voltage	5V	9V
Output Current	1.1A	1.2A
Output Power	5W	10W

241320-63-2

Input Voltage	12V (DC)		
Output Voltage	5V	9V	9V
Output Current	1.1A	1.2A	1.6A
Output Power	5W	10W	15W

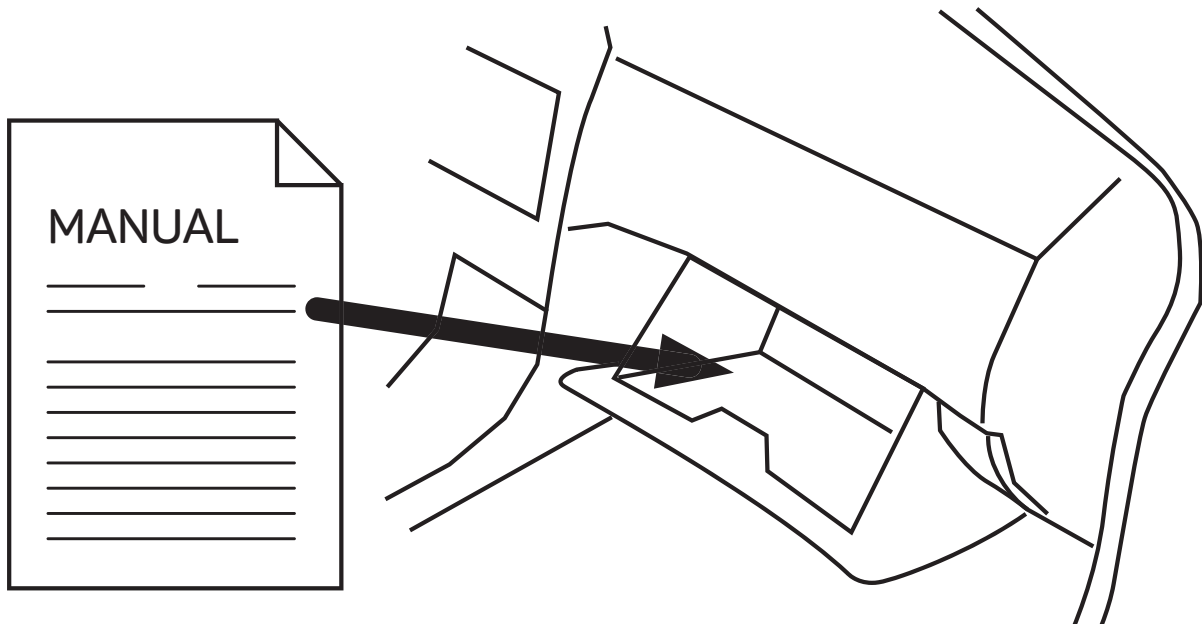

**WICHTIG!** NACH DER INSTALLATION MUSS DIESE EINBAUANLEITUNG IN DAS HANDSCHUHFACH DES KUNDENFAHRZEUGS GELEGT WERDEN.

**IMPORTANT!** AFTER INSTALLATION THE MANUAL HAS TO BE PLACED INTO THE DASH BOARD OF THE CUSTOMER'S CAR.

